

Dimensions

MS 25 motor protection switch

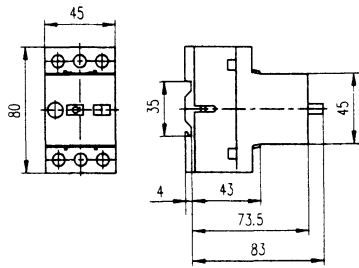

Auxiliary switch

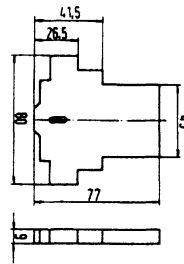

Adapter for fixture with screws

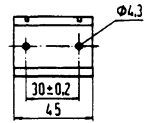

Connection

Proper operation is subject to three-pole switch load; thus all poles are to be used also when only one-pole or two-pole load is necessary. Connections can be:

Connection diagram

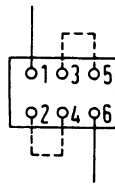

1 - pole

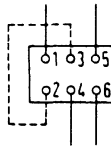

2 - pole

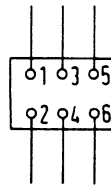

3 - pole

Assembly

Placing of under-voltage release and shunt release

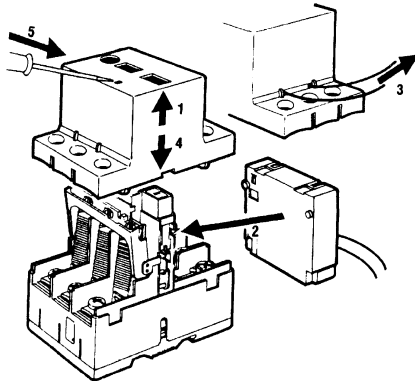

Placing of auxiliary switch

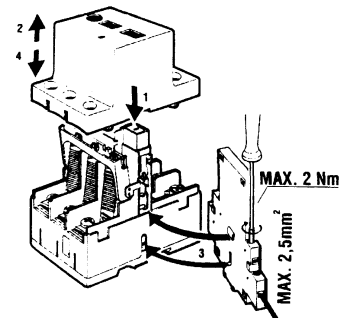

Time-current characteristic

Mean values of operating times for MS 25

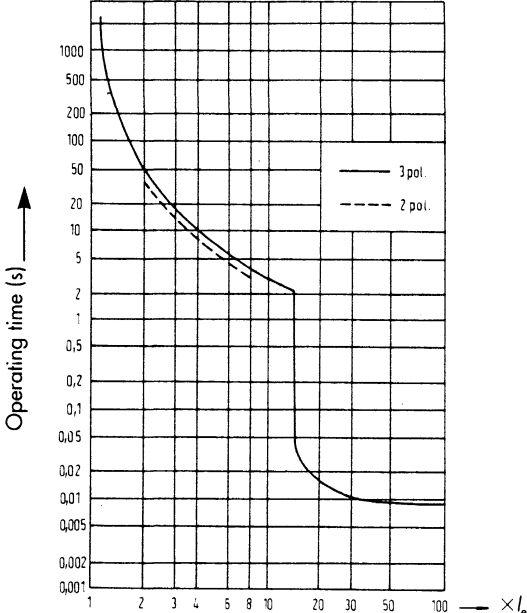

Ambient temperature 20°C

Current as a multiplier of the set current